



DIMENSIONAMENTO E ERGONOMIA

HABITAÇÃO UNIFAMILIAR

Descrição do material



- **RESUMO/CONTEXTO:** Material apresentado na disciplina de Desenho Arquitetônico II do Curso de Expressão Gráfica com o intuito de fornecer alguns conceitos básicos e iniciais sobre dimensionamento mínimo e ergonomia de ambientes de uma residência, para que os alunos possam desenvolver o trabalho de projeto arquitetônico de uma residência unifamiliar em Curitiba/PR.
- **AUTOR:** Prof. Msc. Márcio Henrique de Sousa Carboni.
- **TEMAS ABORDADOS:** Dimensionamento, Habitação Unifamiliar, Ergonomia, Antropometria.
- **DISCIPLINAS ENVOLVIDAS:** Desenho Arquitetônico, Projeto arquitetônico.
- **EXTENSÃO DO MATERIAL:** .PDF (Executável no software Adobe Reader, Foxit PDF Reader e outros).

Tipo de licença



Este trabalho está licenciado com uma Licença Creative Commons - Atribuição 4.0 Internacional.

- Você é livre para compartilhar esse texto em qualquer meio ou formato e adapta-lo (remixar, transformar, construir em cima desse material, entre outros) para qualquer finalidade, inclusive comercial, desde que cite devidamente a fonte (indicando o autor, ano, fornecendo o link de onde baixou e indicando alterações feitas no material). O autor pode revogar essas liberdades se os termos não forem cumpridos ou for atribuído mau uso do material.

Como citar



- CARBONI, M. H. S. HABITAÇÃO UNIFAMILIAR: DIMENSIONAMENTO E ERGONOMIA. Curitiba, 2015. Disponível em:<inserir URL do link do arquivo>. Acessado em: 27.mai.2015.

Habitação Unifamiliar



■ Ambientes:

- Garagem
- Estar e Jantar
- Lavabo
- Cozinha (copa)
- Lavanderia
- Escritório
- Quartos
- Banheiros

■ Funções:

- Dormir
- Comer
- Assear
- Armazenar
- Lazer
- (Trabalhar)

Organização e fluxos

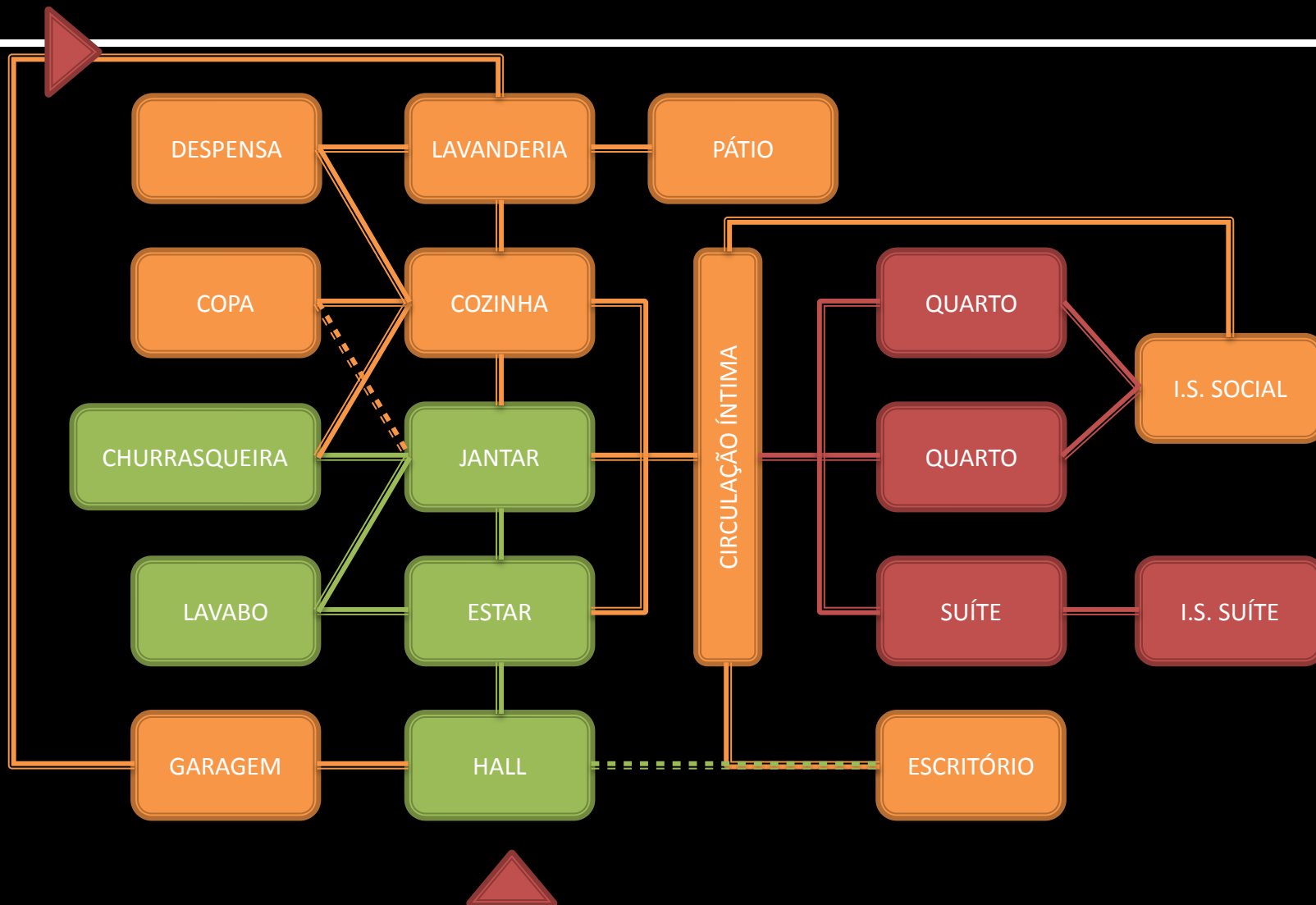

Organização e fluxos

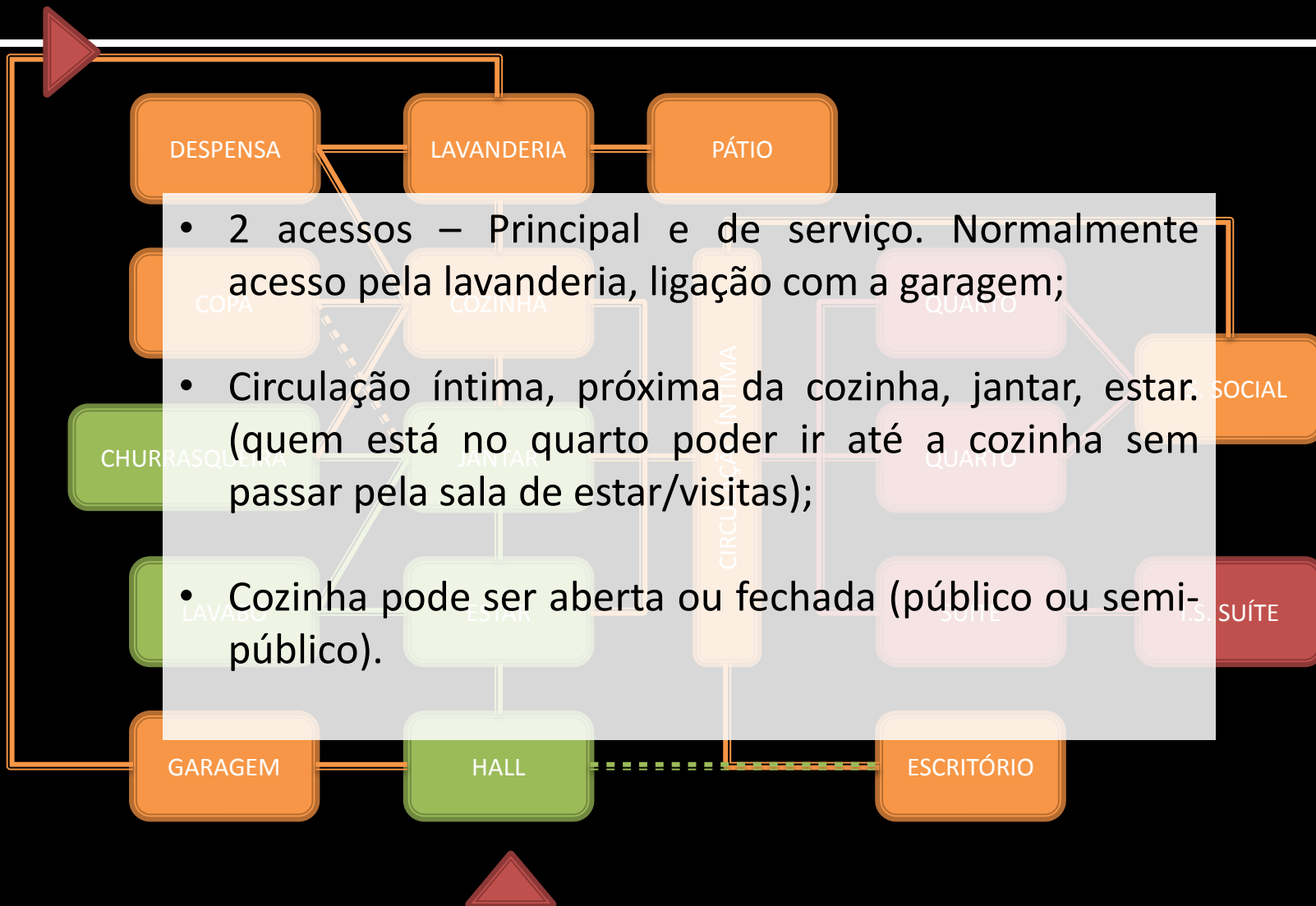

Orientação



PRIORIDADES
HIERARQUIA – PERMANÊNCIA

O QUE É ERGONOMIA?

Ergonomia



- É a disciplina científica relacionada ao entendimento das **interações** entre seres **humanos** e outros **elementos** de um sistema (por exemplo, uma residência);
- Ergonomia de Interiores - Está ligada ao conforto, segurança e eficiência das atividades desenvolvidas no espaço interior, onde o objetivo principal está em **respeitar os espaços mínimos de circulação, deslocamento, necessidades e limitações físicas**.

Ergonomia



■ ERGONOMIA → ANTROPOMETRIA

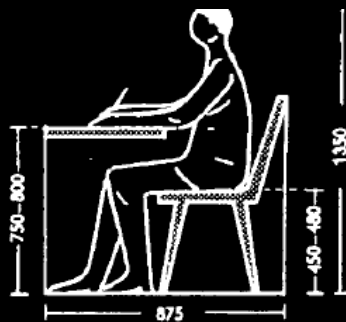

13 Medidas em cadeira de trabalho

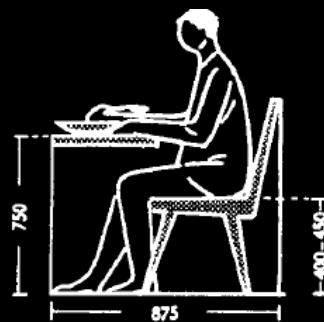

14 Medidas em cadeira de comer

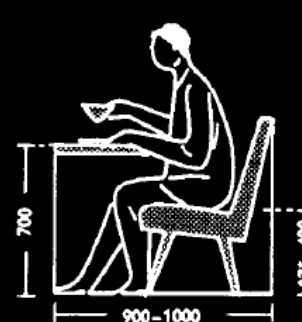

15 Medidas em cadeira pequena para mesa de chá e máquina de coser



16 Medidas em poltrona

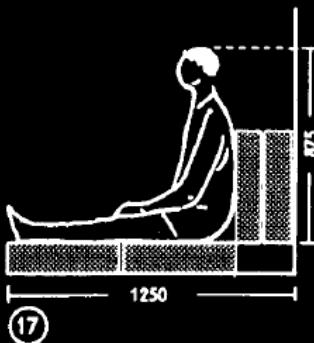

17

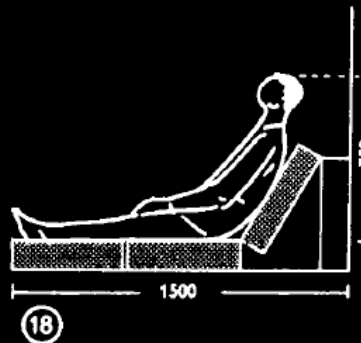

18

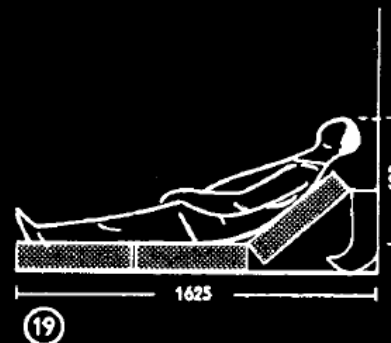

19

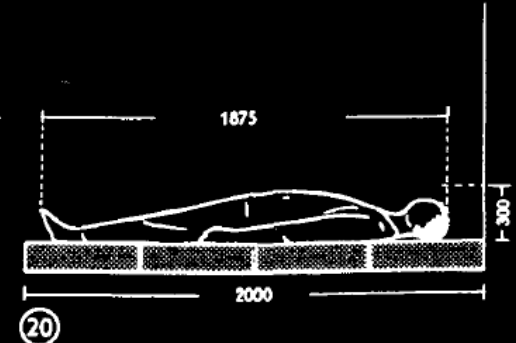

20

MEDIDAS DO CORPO

O HOMEM DIMENSÕES E ESPAÇOS NECESSÁRIOS

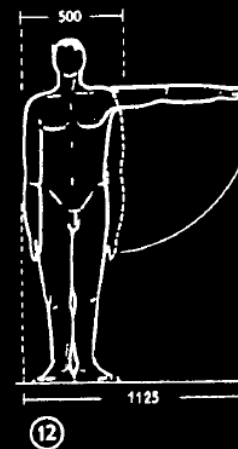
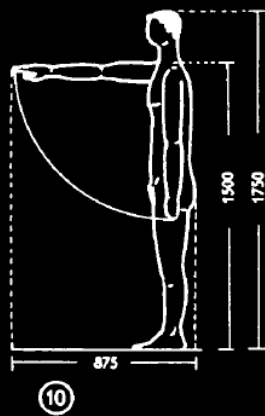
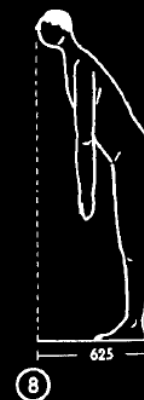
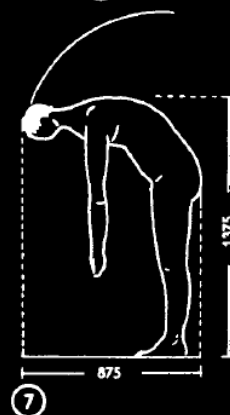
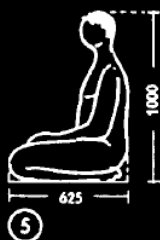
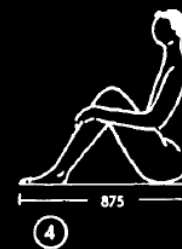
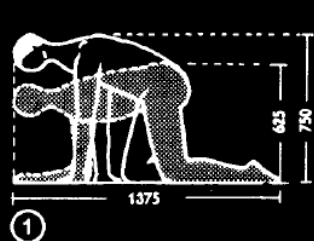

Garagem



- Qual a dimensão mínima de uma vaga?
- Legislação de Curitiba:
 - 1 vaga para cada habitação
 - Vaga mínima 2,40 x 5,00 m
 - Para Habitação Unifamiliar permitido **2,20 x 4,50m**
 - Inclinação rampa veículos = máx. 25%

Garagem

- Além da dimensão mínima é importante que haja espaço ao redor da vaga para circulação



Garagem

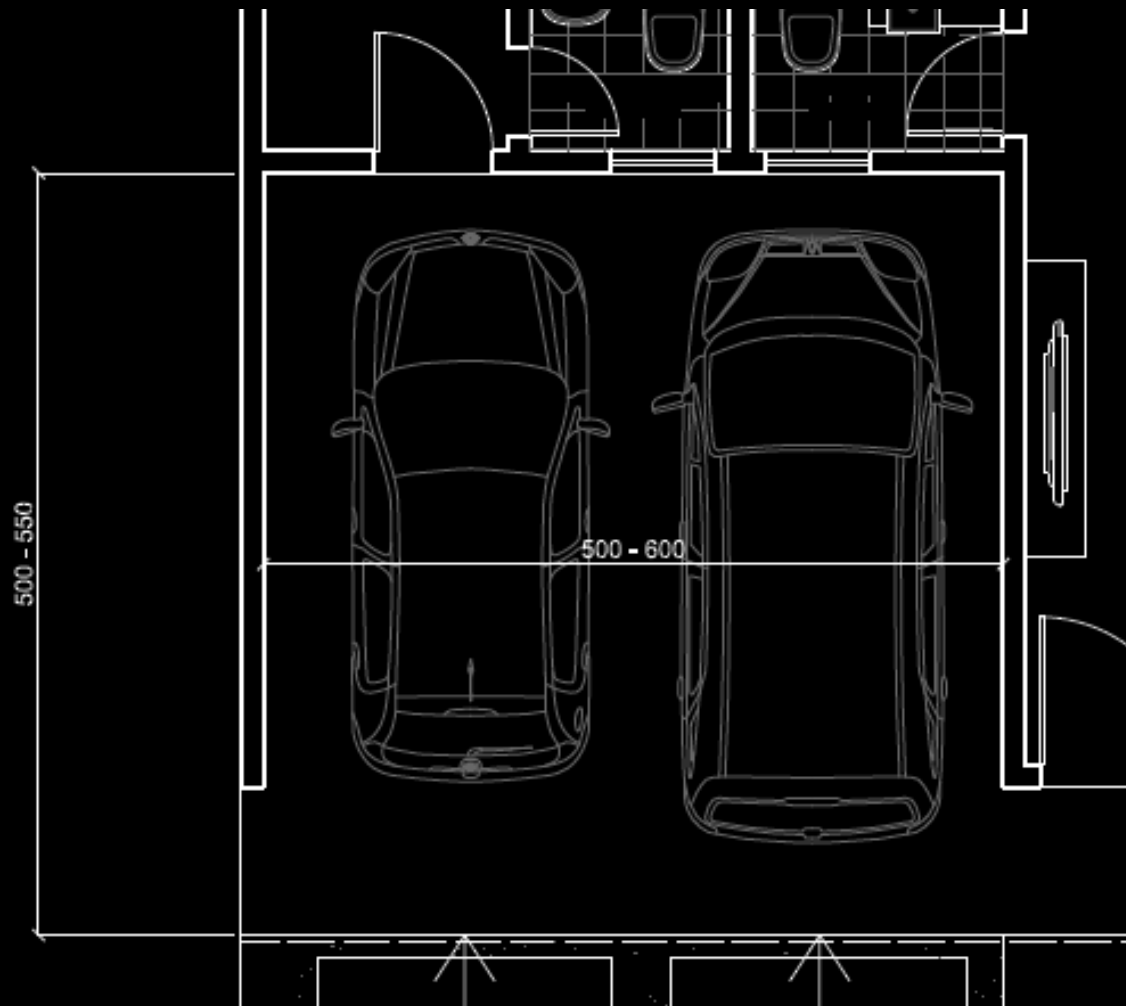

■ Entre paredes

■ 2 carros:

■ 5x5,5m

■ 1 carro:

■ 5x3m

Garagem - bicicletário

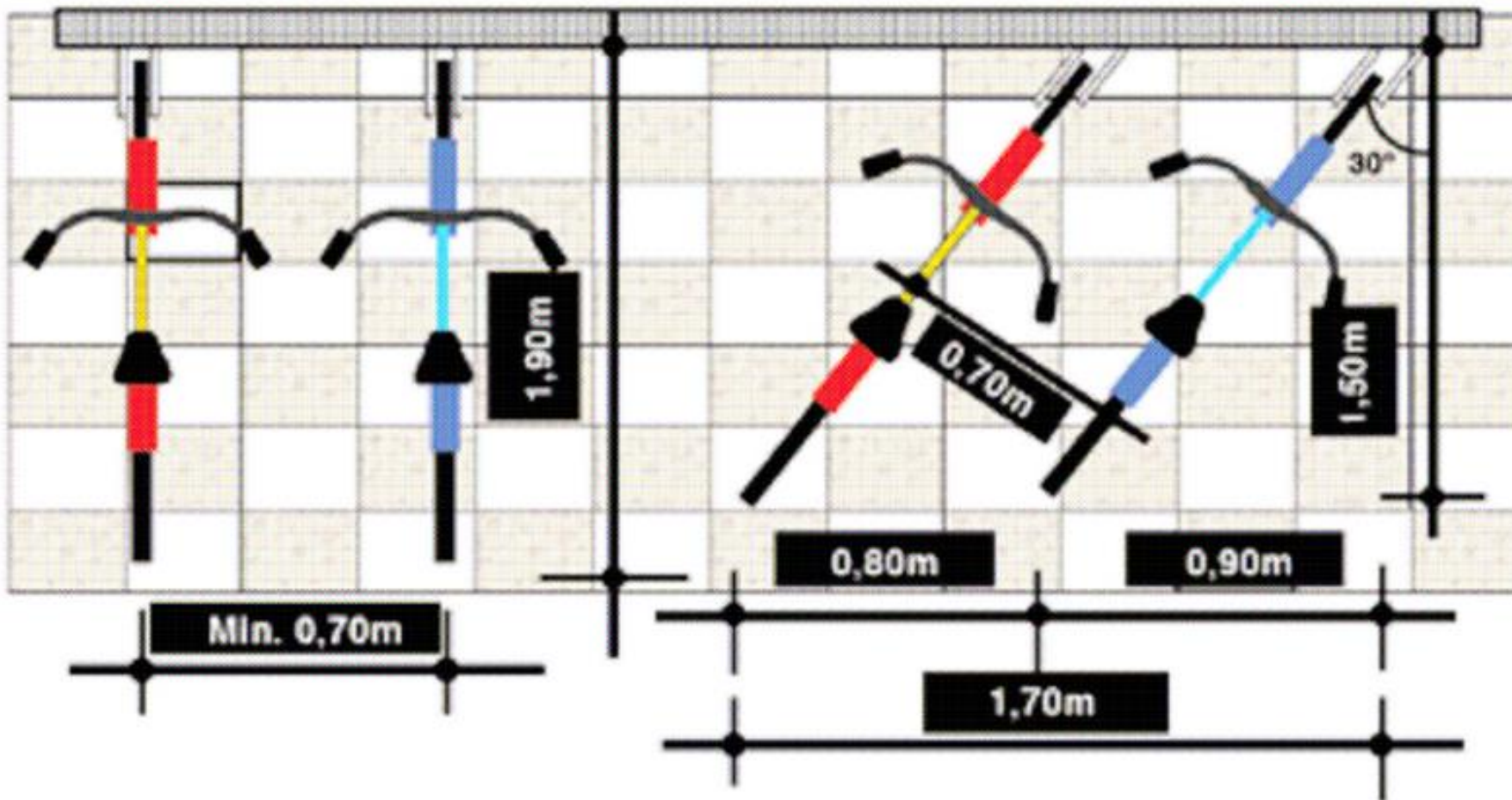

Cozinhas

- Para o bom funcionamento é importante observar:
 - Atividades relativas e utensílios/mobiliário adequado
 - Caminhos curtos
 - Linha de trabalho fluente
 - Suficiente espaço de movimentação.



Cozinhas

■ Atividades na cozinha:

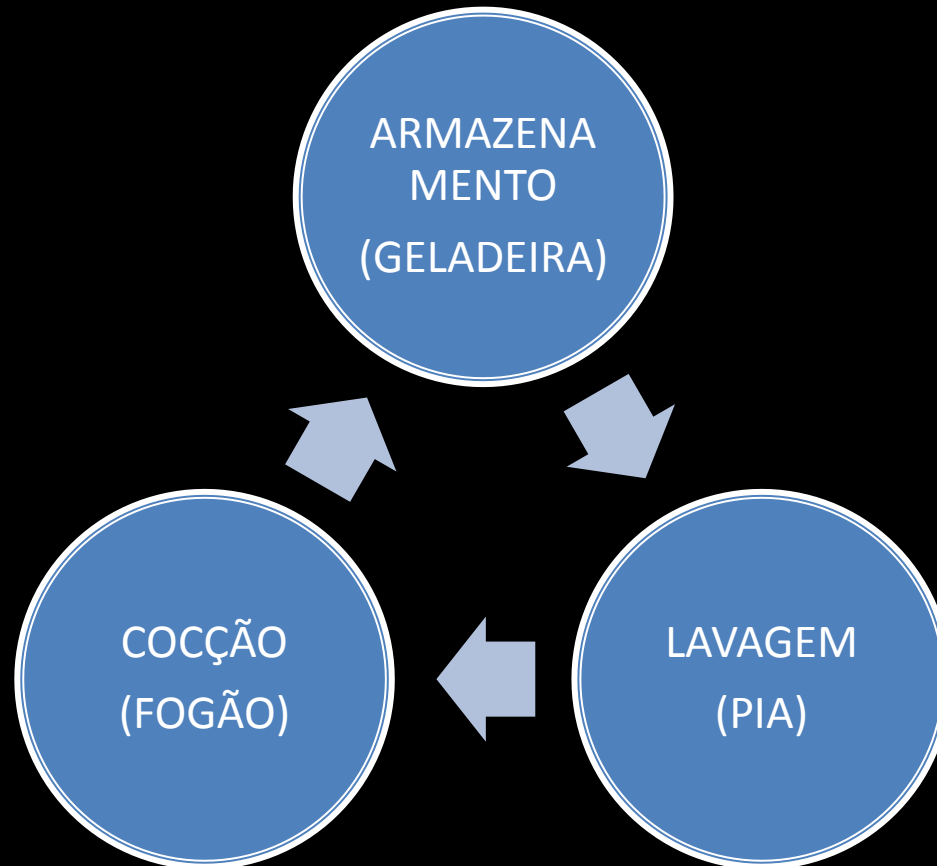

Cozinha



One Wall

The Island

The L

The Peninsula

Cozinha

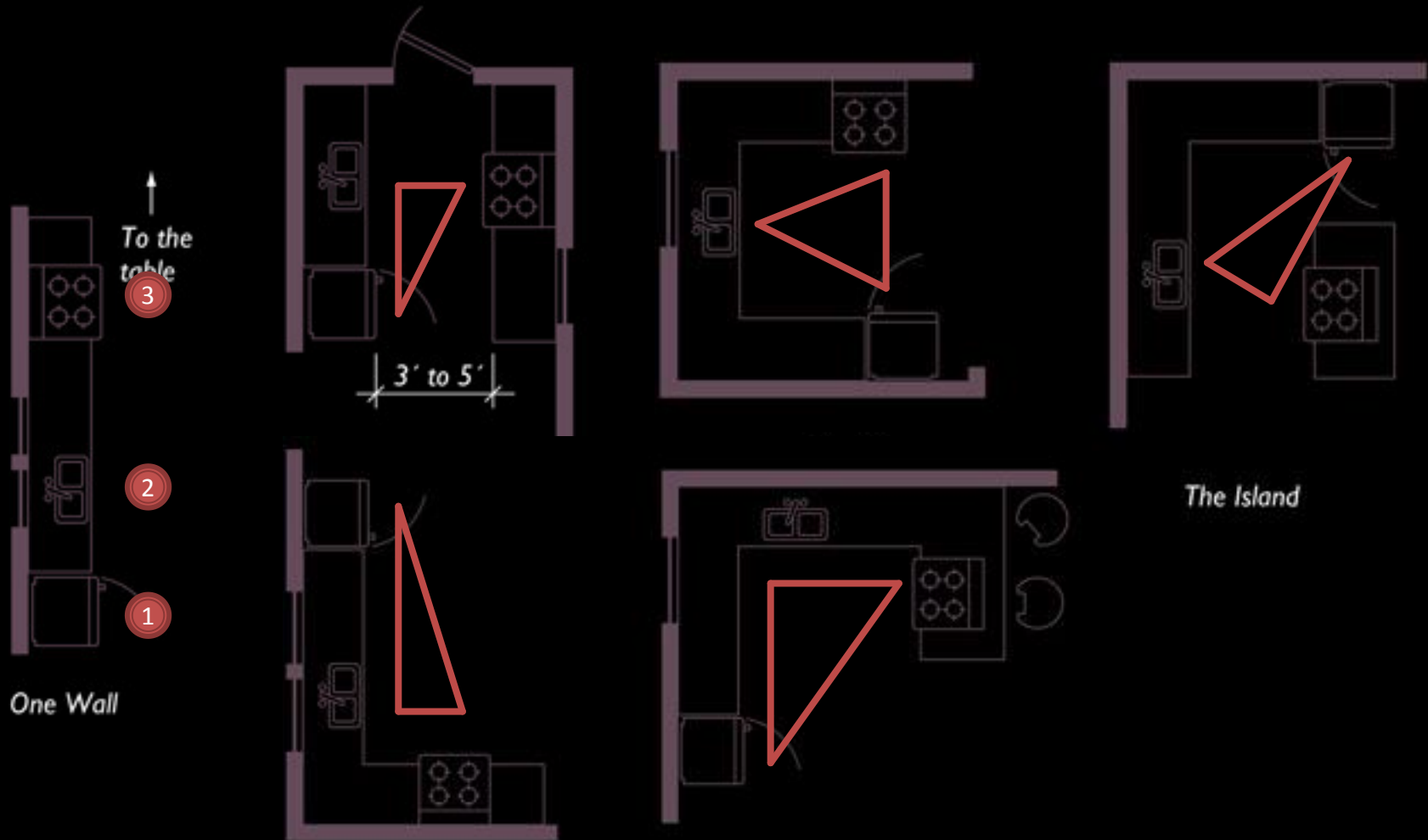

Cozinha



Cozinhas

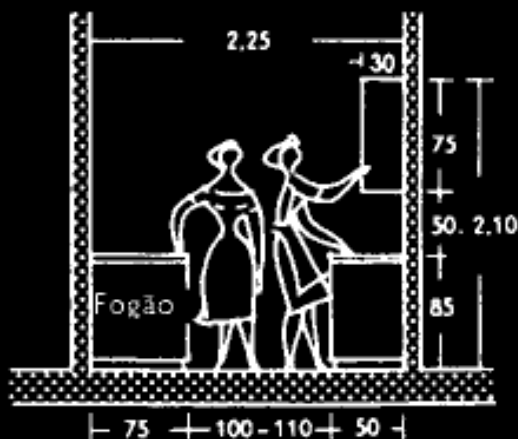

- ② Corte transversal de cozinha de habitação pequena, com espaço para a dona de casa e uma eventual auxiliar

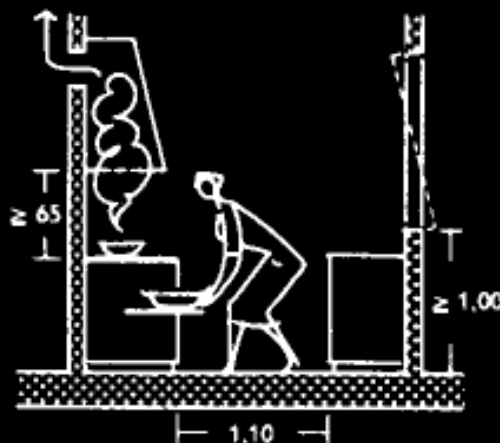

- ③ O forno ou a grelha extraível debaixo dos fogões exigem um certo espaço de movimento. Sobre o fogão instala-se um apanha-fumos

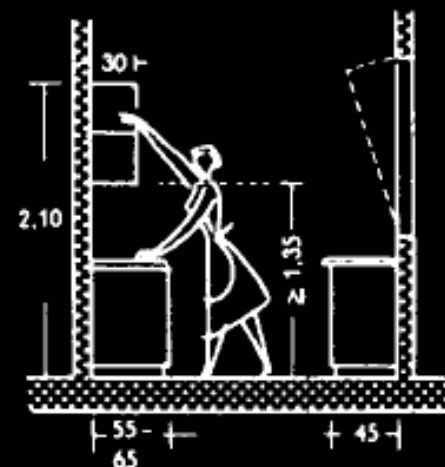

- ④ Largura das mesas de cozinha 55 a 65 cm. Planos auxiliares: 45 cm

Cozinhas

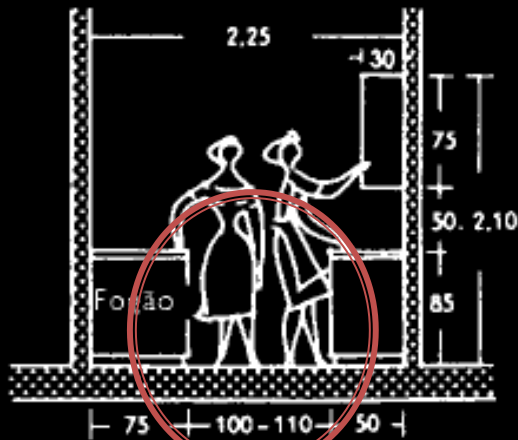

- ② Corte transversal de cozinha de habitação pequena, com espaço para a dona de casa e uma eventual auxiliar

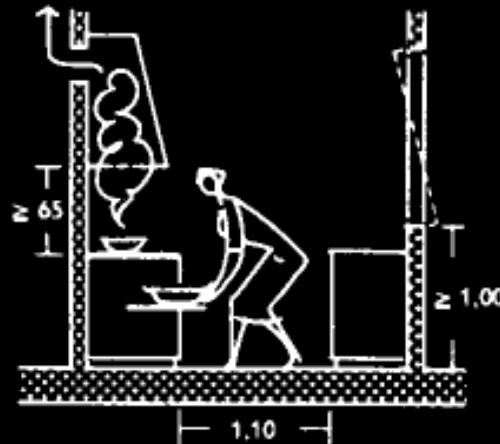

- ③ O forno ou a grelha extraível debaixo dos fogões exigem um certo espaço de movimento. Sobre o fogão instala-se um apanha-fumos

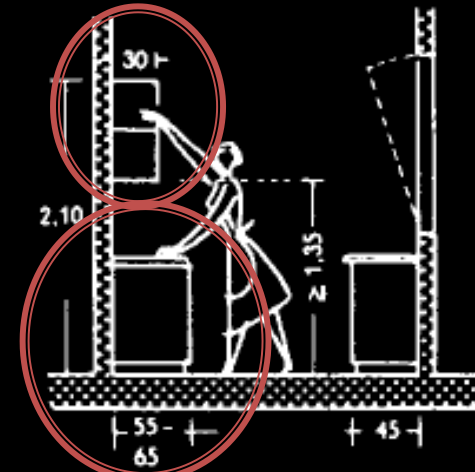

- ④ Largura das mesas de cozinha 55 a 65 cm. Planos auxiliares: 45 cm

- Bancadas = 60cm profundidade
- Armário alto = 30cm – 40cm profundidade
- Espaçamento entre bancadas = 1m - 1,10m

Cozinhas

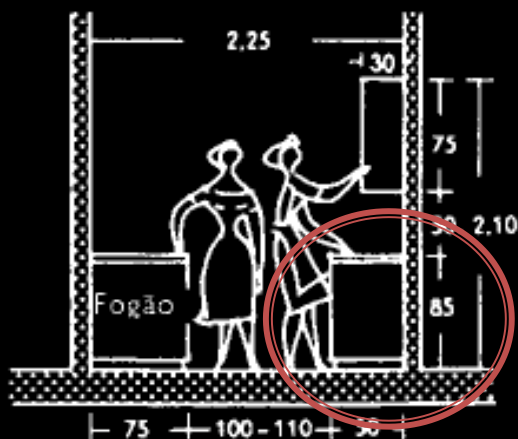

- ② Corte transversal de cozinha de habitação pequena, com espaço para a dona de casa e uma eventual auxiliar

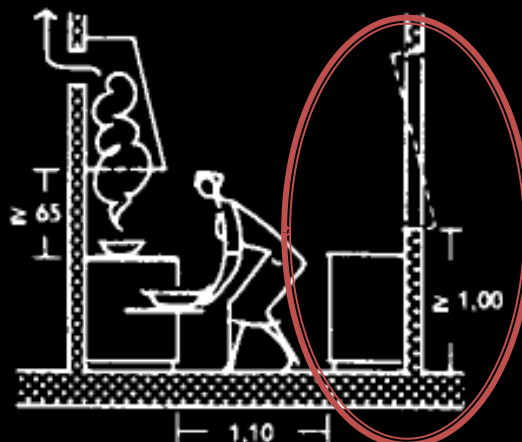

- ③ O forno ou a grelha extraível debaixo dos fogões exigem um certo espaço de movimento. Sobre o fogão instala-se um apanha-fumos

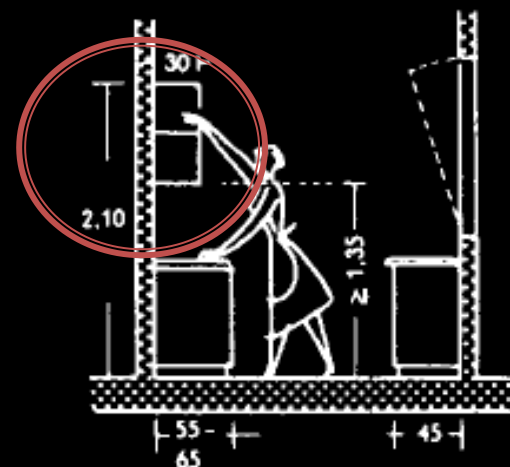

- ④ Largura das mesas de cozinha 55 a 65 cm. Planos auxiliares: 45 cm

- Peitoril janela sobre pia = mín. 1m
- Altura bancada = 85cm
- Altura armário alto = 1,35m até 2,10m

- Quais são os elementos básicos?



Jantar

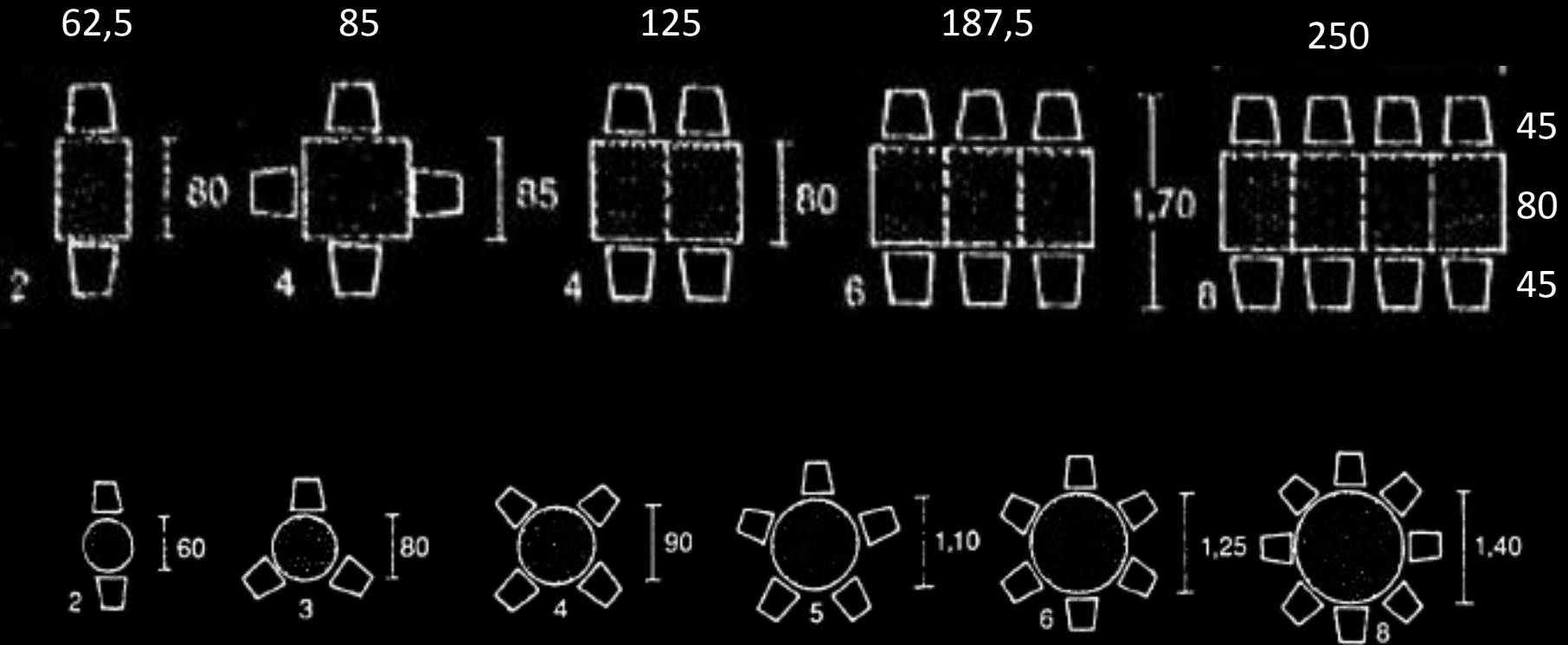

Jantar

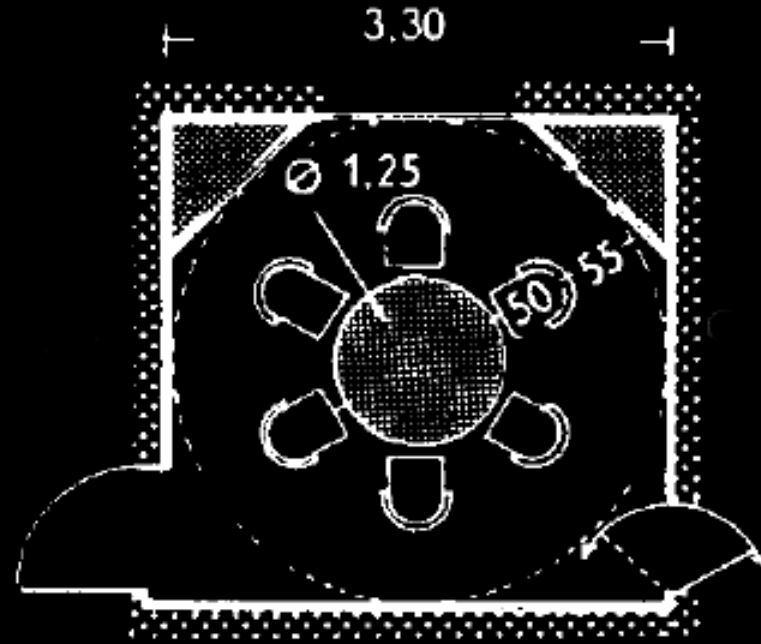
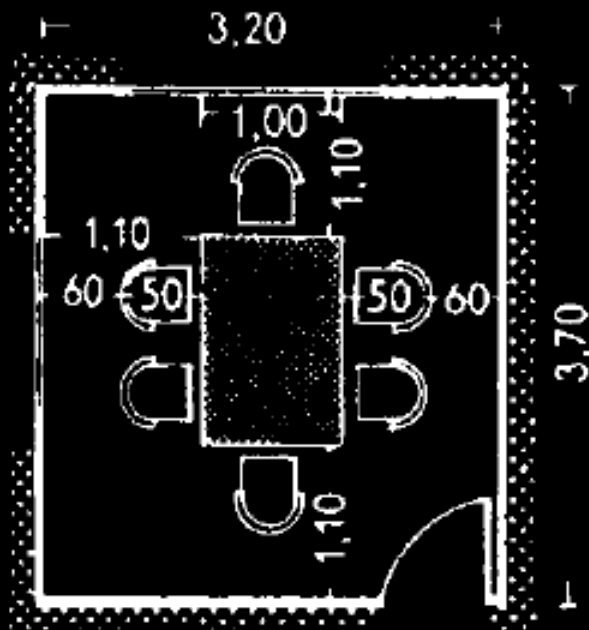

- 8 Sala de jantar mínima para seis pessoas, de mesa central mas sem armários (porta de canto)

- 9 Sala mínima para seis pessoas com mesa redonda e armários de canto. Ligada à cozinha por porta pendular

Jantar

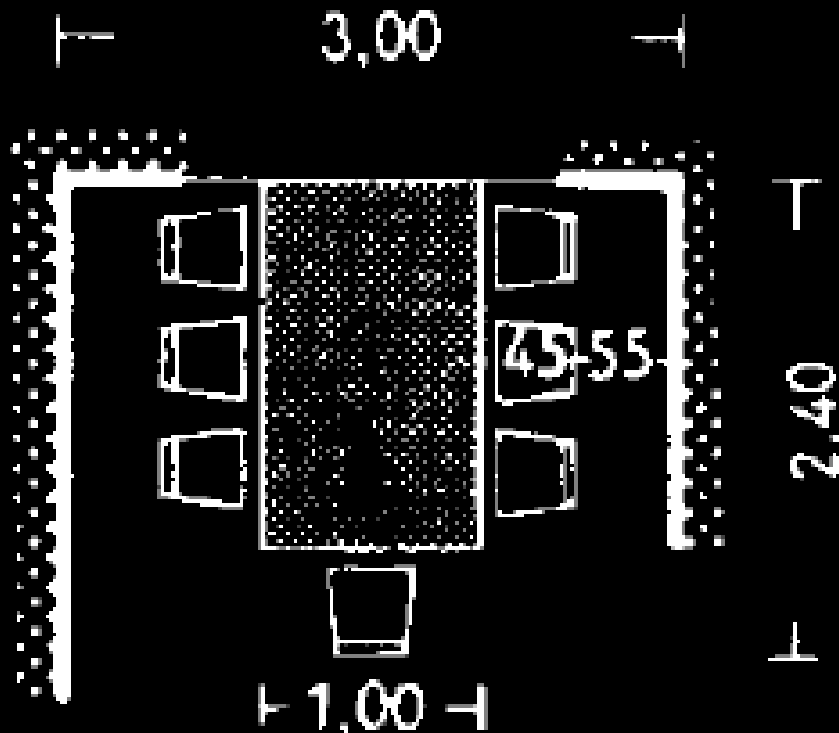

- Mesa mínima 80cm
- Espaçamento cadeiras = 45cm
- Espaçamento mínimo de 55cm atrás das cadeiras.

- É o ambiente mais difícil de se definir devido às inúmeras finalidades possíveis:
 - Assistir TV
 - Leitura
 - Convivência (conversas)
 - Lareira
 - “Todas as anteriores”

Estar

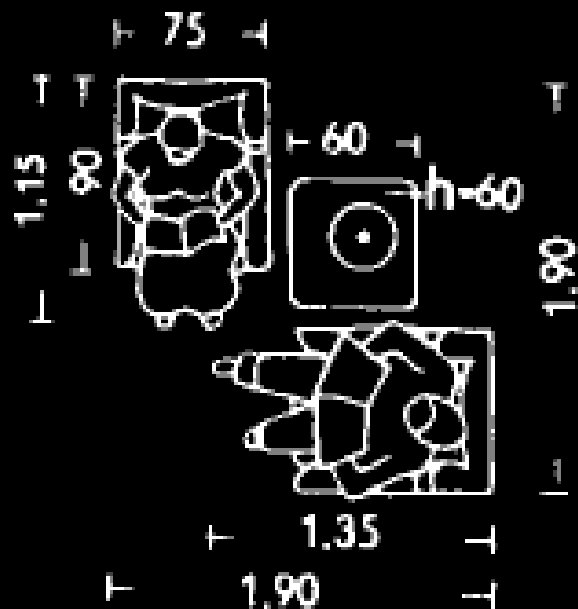

- 1 As poltronas cômodas para ler e conversar organizam-se em conjuntos com mesa baixa e lâmpada de pé alto

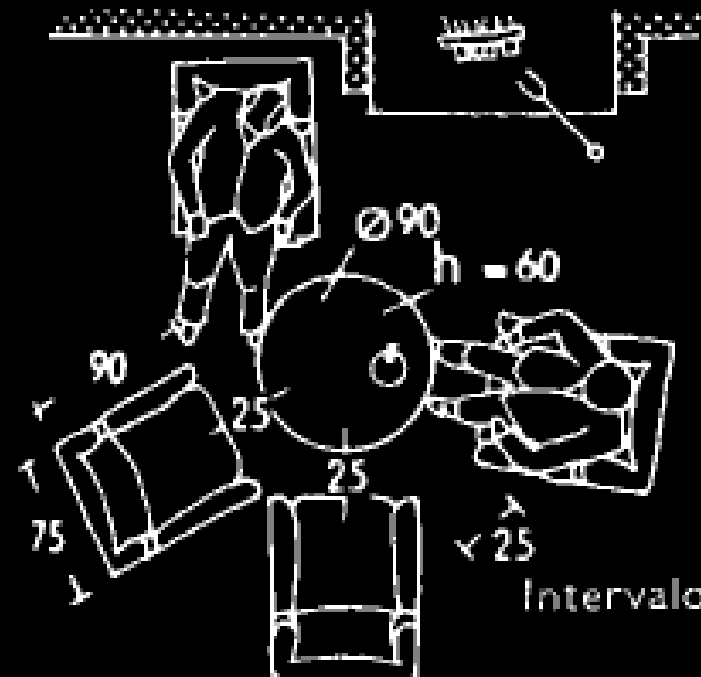

- 2 Mesa de convívio junto da lareira da sala (ligeiramente desviada devido à radiação e para deixar espaço para cuidar do fogo)

Quartos

- Quais os elementos básicos?



Quartos

■ Camas:

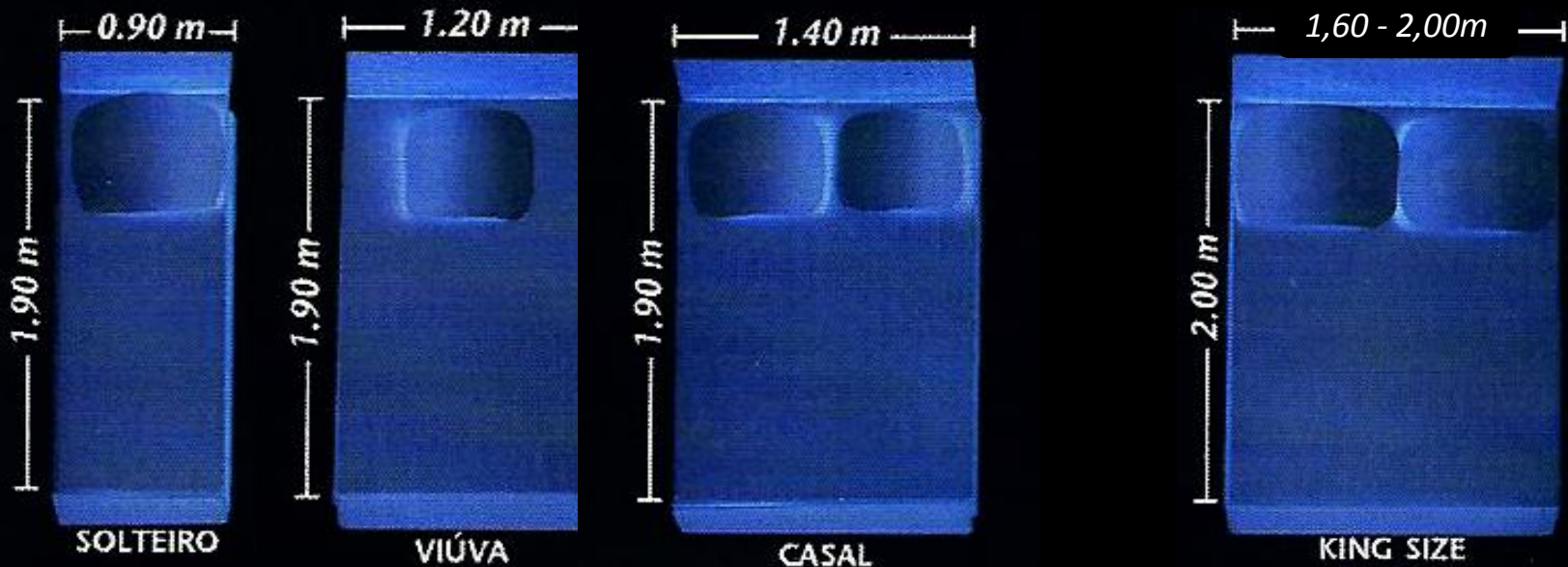

PADRÃO MAIS USUAL

■ Camas mínimas

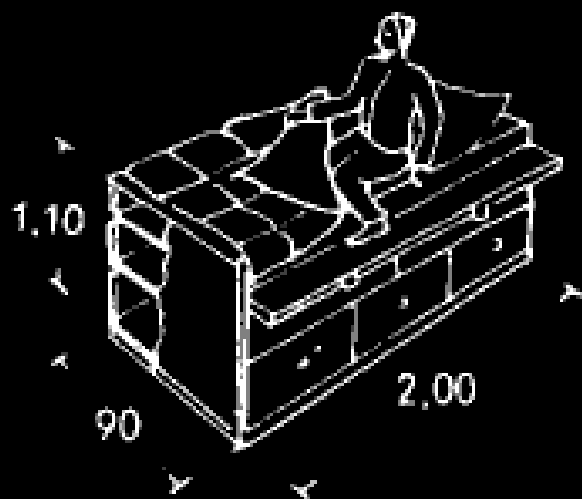

9

Cama alta sôbre armário com grandes gavetões e tabuleiro de correr que durante o dia serve de tampa para o vão onde se guarda a roupa

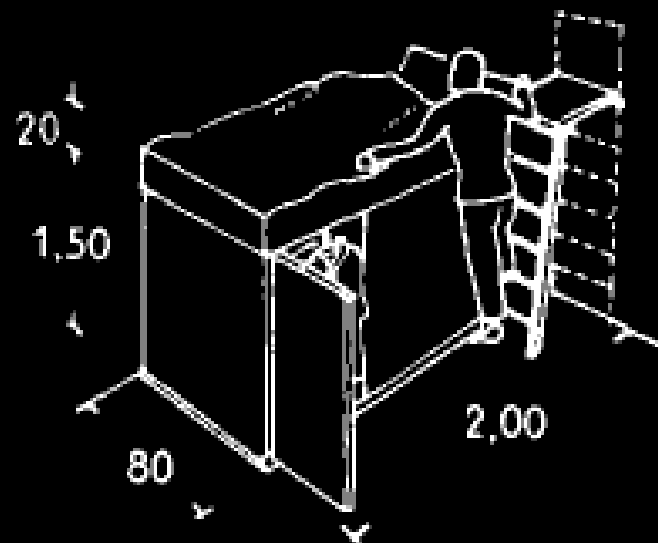

10

Cama sôbre armário roupeiro baixo para compartimentos muito pequenos (estúdios, camarotes, etc.)

■ Camas mínimas

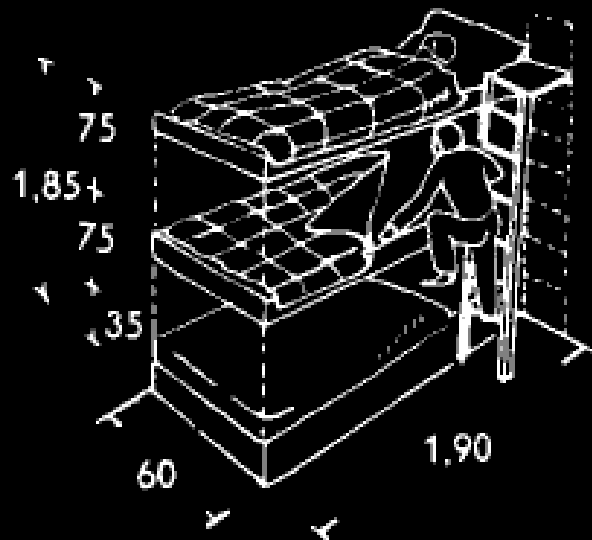

- ⑪ **Beliches de três pisos** para carruagem cama, casas de fim de semana e quartos de crianças. Área por pessoa:
 $0,60 \times 1,90 : 3 = 0,38 \text{ m}^2$

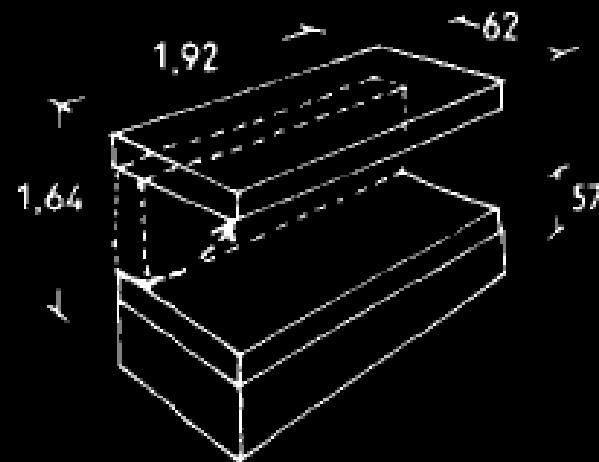

- ⑫ **Beliche de «pullman»**. Por rotação do encôsto forma-se o leito superior → pág. 335

Quartos

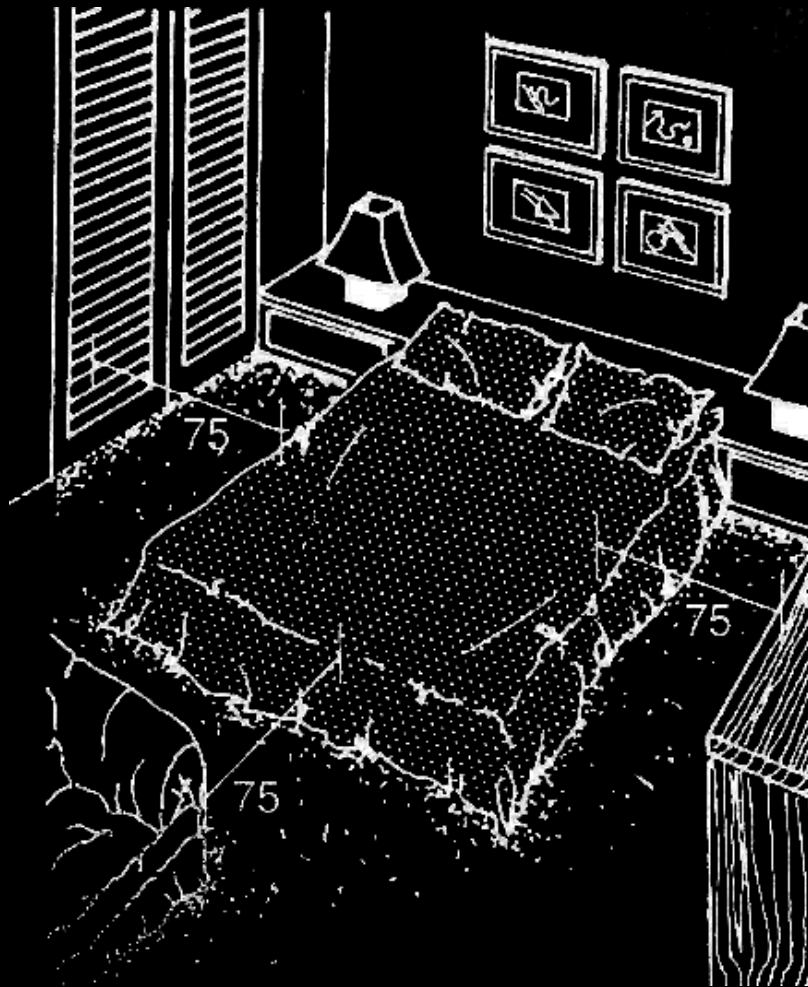

- Espaço livre ao redor da cama – mínimo 75cm
- Armários = 60cm profundidade

Quartos

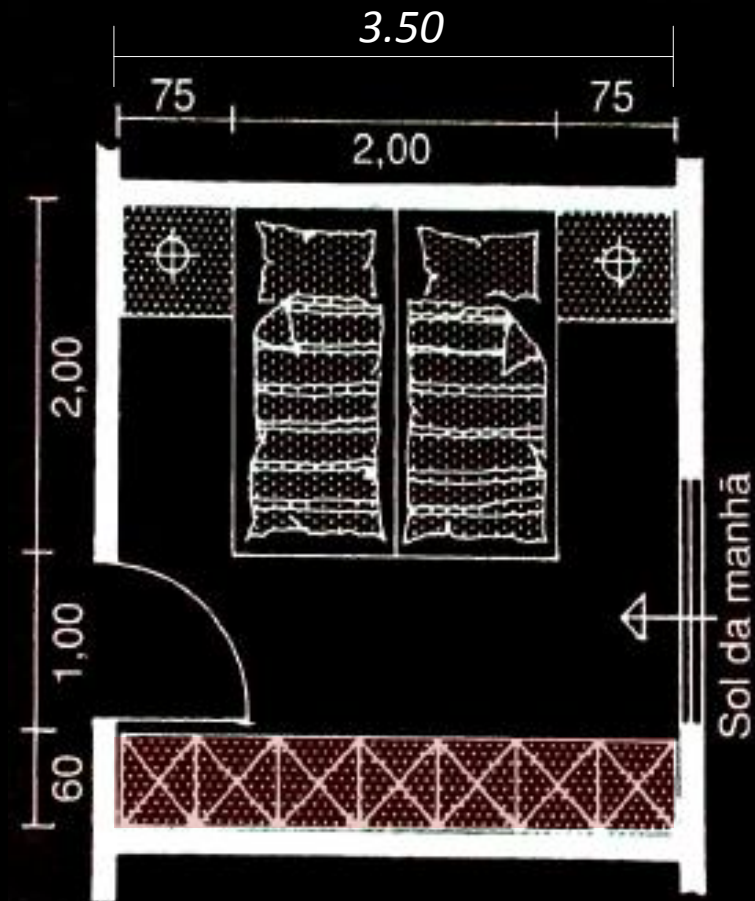
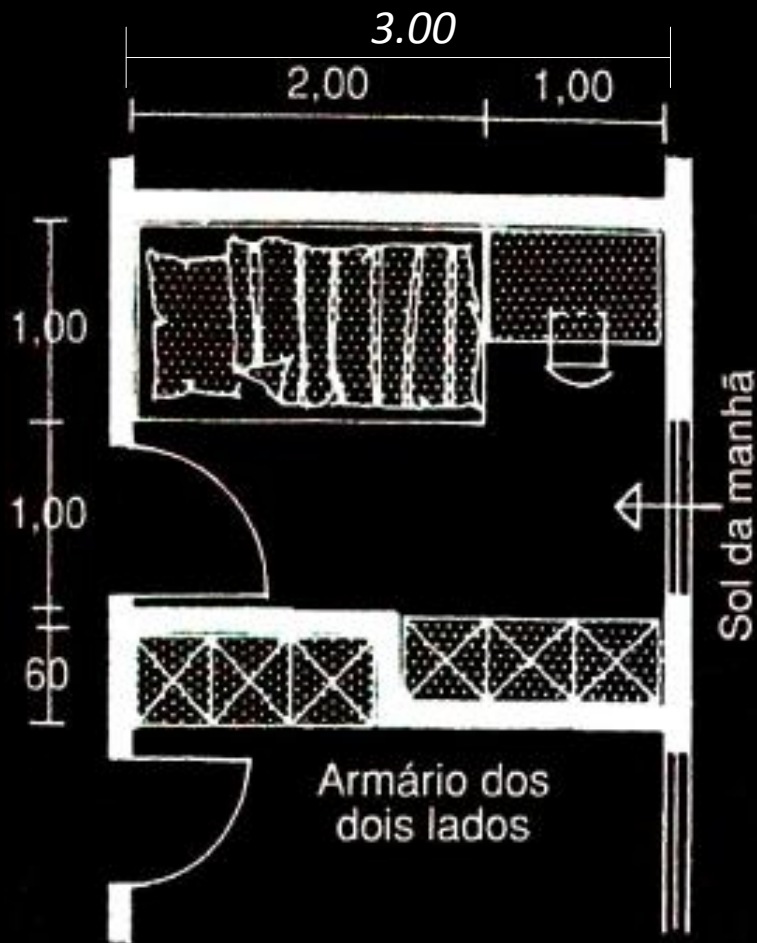

Quartos

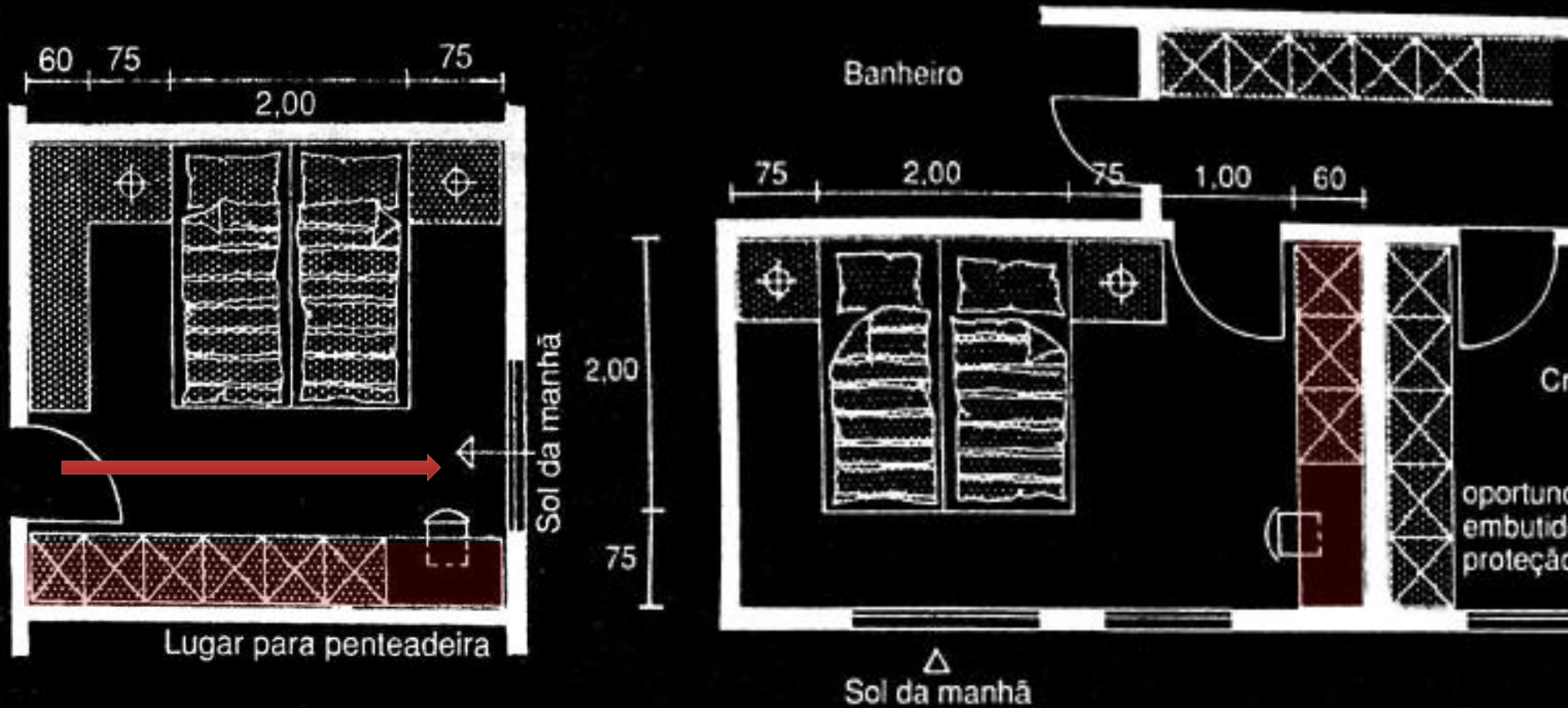

Quartos

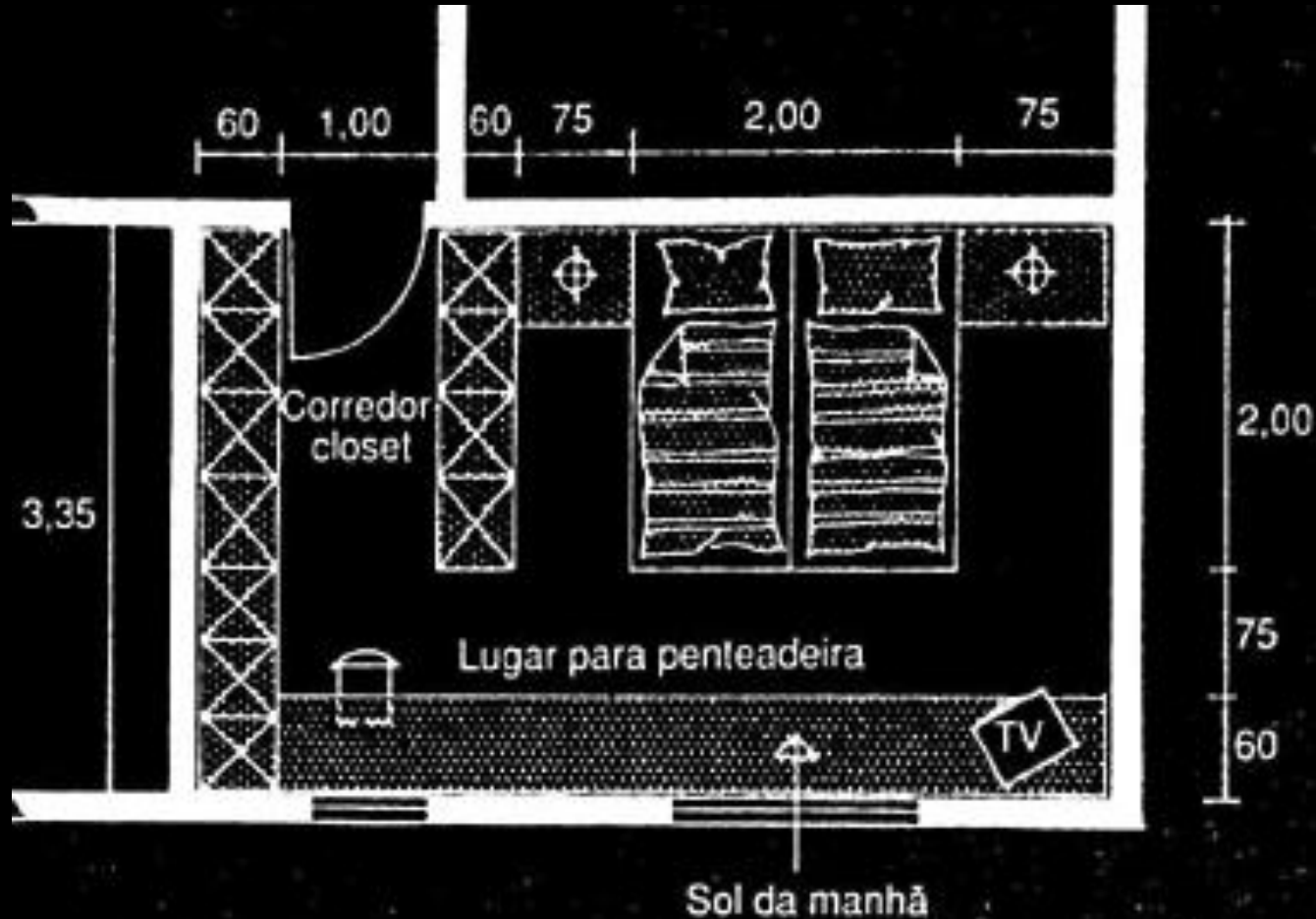

Quartos

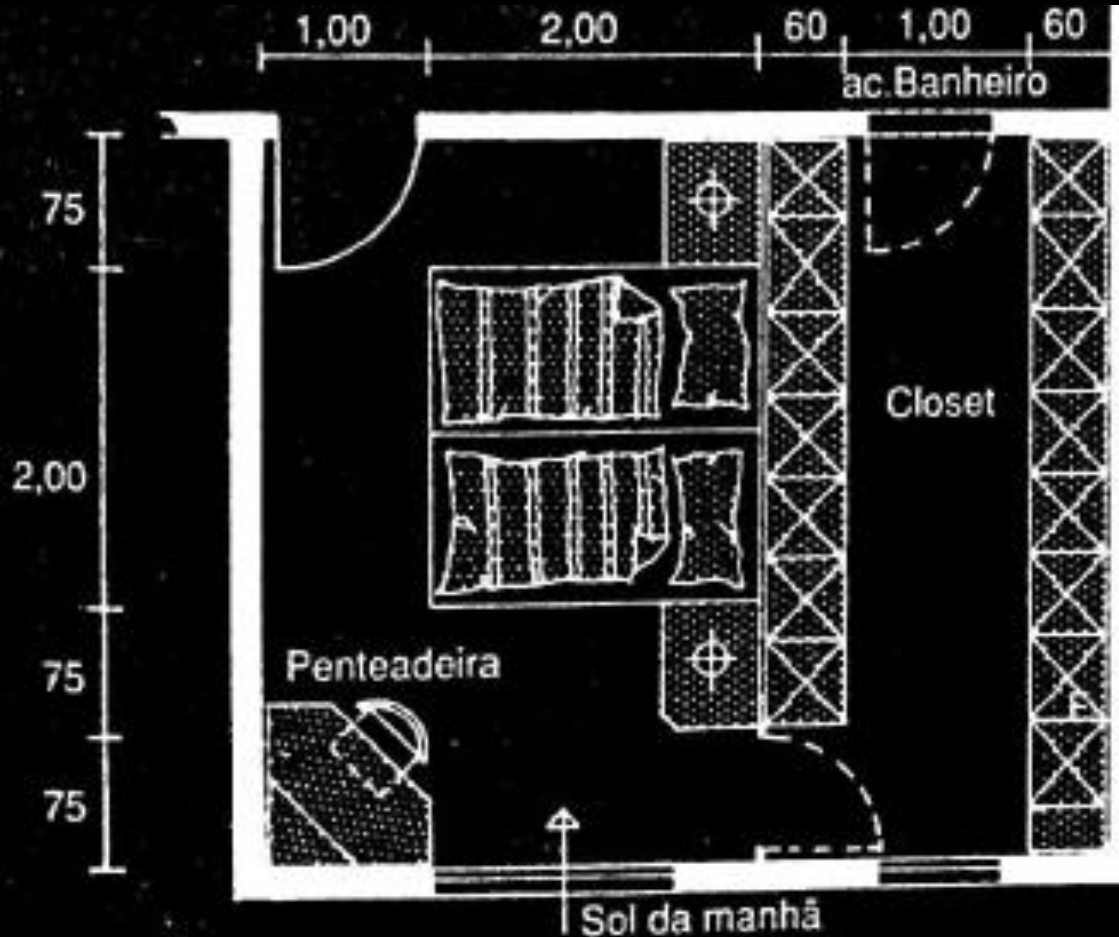

Quartos

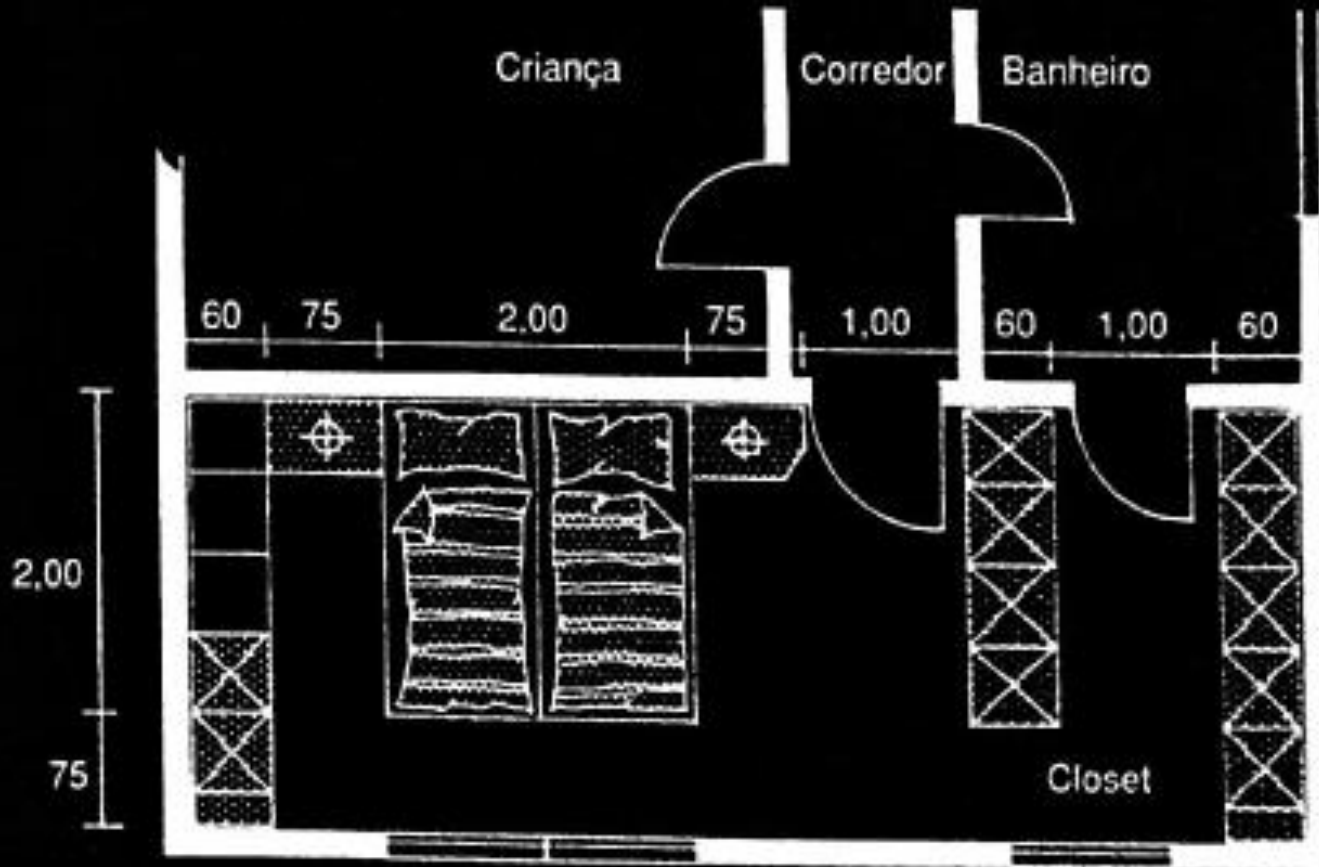

Banheiros

- Assim como a cozinha, existe uma hierarquia de usos de define disposição dos elementos.

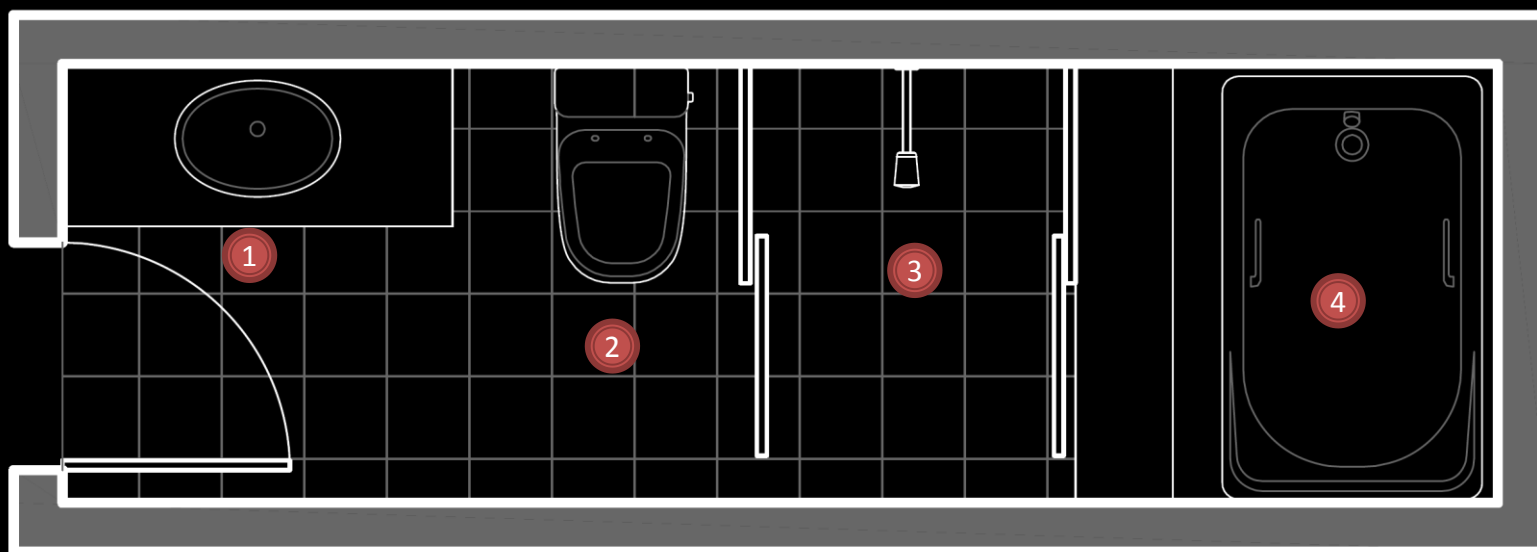

Banheiros

■ Dimensionamento mínimo:

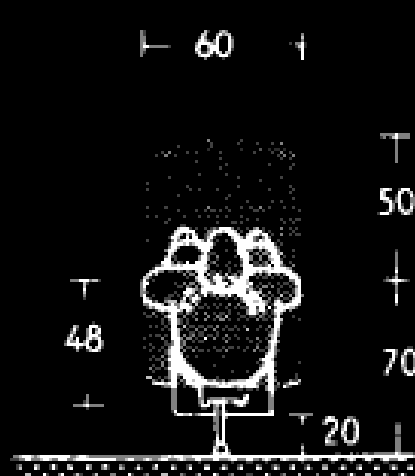

Áreas mínimas

12 para retrete com depósito elevado ou fluxômetro

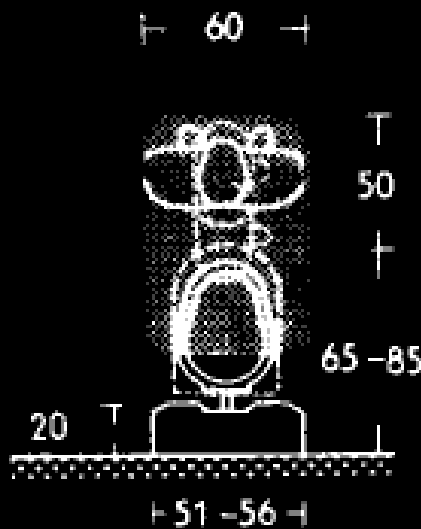

13 para retrete com depósito baixo

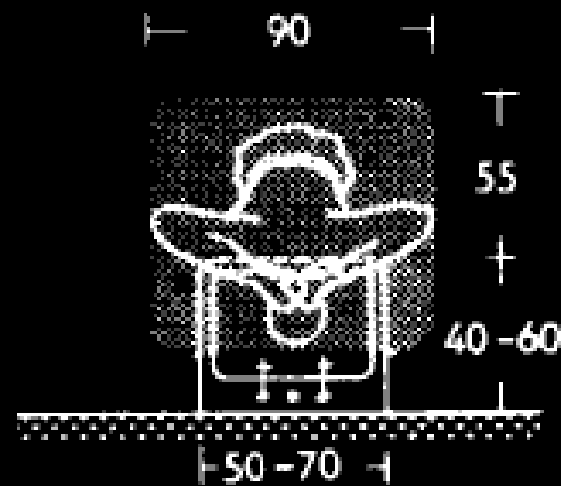

15 para lavatório simples

Banheiros

- Box – mínimo 90x90cm



Referências



- NEUFERT, Ernest. A arte de projetar em arquitetura. São Paulo: Ed. Gustavo Gili, 1976.
- NEUFERT, Neff. Casa, apartamento e jardim. São Paulo: Ed. Gustavo Gili, 1999.
- PANERO, J. & Zelnik, M. Dimensionamento humano para espaços interiores. Barcelona: Gustavo Gili: 2001

